



Figure can vary

**Part no.: 50133669**  
**PRK3C.TT3/LP**  
**Polarized retro-reflective photoelectric sensor**



 **IO-Link**



## Contents

- Technical data
- Reflectors & reflective tapes
- Dimensioned drawings
- Electrical connection
- Diagrams
- Operation and display
- Part number code
- Accessories
- Notes

## Technical data

<b>Basic data</b>	
Series	3C
Operating principle	Reflection principle
Application	Detection of transparent films Detection of highly transparent bottles
<b>Special design</b>	
Special design	Tracking function Autocollimation
<b>Optical data</b>	
Operating range	Guaranteed operating range
Operating range	0 ... 3 m, With reflector TK(S) 100x100
Operating range limit	Typical operating range
Operating range limit	0 ... 3.6 m, With reflector TK(S) 100x100
Light source	LED, Red
LED light wavelength	635 nm
Transmitted-signal shape	Pulsed
LED protection class	Exempt group (in acc. with EN 62471)
<b>Electrical data</b>	
Protective circuit	Short circuit protected Polarity reversal protection
<b>Performance data</b>	
Supply voltage	10 ... 30 V, DC, Incl. residual ripple
Residual ripple	0 ... 15 %, From $U_B$
Open-circuit current	0 ... 15 mA
<b>Outputs</b>	
Number of digital switching outputs	2 Piece(s)
<b>Switching outputs</b>	
Voltage type	DC
Switching current, max.	100 mA
Switching voltage	Low: $\leq 2V$ High: $\geq (U_B - 2V)$
<b>Switching output 1</b>	
Assignment	Connection 1, conductor 4
Switching element	Transistor, Push-pull
Switching principle	IO-Link / light switching (PNP)/dark switching (NPN)
<b>Switching output 2</b>	
Assignment	Connection 1, conductor 2
Switching element	Transistor, PNP
Switching principle	Dark switching
<b>Timing</b>	
Switching frequency	1,500 Hz
Response time	0.33 ms
Readiness delay	300 ms
Response jitter	110 $\mu s$

**Interface**

Type	IO-Link
<b>IO-Link</b>	
COM mode	COM2
Frame type	2.5
Specification	V1.1
SIO-mode support	Yes
Min. cycle time	COM2 = 2.3 ms

**Connection**
**Connection 1**

Type of connection	Cable
Function	Voltage supply Signal IN Signal OUT
Cable length	2,000 mm
Sheathing material	PUR
Cable color	Black
Number of conductors	4 -wire
Wire cross section	0.2 mm <sup>2</sup>

**Mechanical data**

Dimension (W x H x L)	11.4 mm x 34.2 mm x 18.3 mm
Housing material	Plastic, PC-ABS
Lens cover material	Plastic / PMMA
Net weight	50 g
Housing color	Red
Type of fastening	Via optional mounting device Through-hole mounting
Compatibility of materials	ECOLAB

**Operation and display**

Type of display	LED
Number of LEDs	2 Piece(s)
Operational controls	Teach button
Function of the operational control	Sensitivity adjustment

**Environmental data**

Ambient temperature, operation	-10 ... 60 °C
Ambient temperature, storage	-40 ... 70 °C



**Certifications**

Degree of protection	IP 67 IP 69K
Protection class	III
Certifications	c UL US
Standards applied	IEC 60947-5-2

**Classification**

eCl@ss 8.0	27270902
eCl@ss 9.0	27270902

## Reflectors & reflective tapes

	Part no.	Designation	Operating range/ Operating range limit	Description
	50117583	MTKS 50x50.1	0 ... 1.3 m 0 ... 1.6 m	Design: Rectangular Reflective surface: 50 mm x 50 mm Triple reflector size: 1.2 mm Material: Plastic Base material: Plastic Chemical designation of the material: PMMA8N Fastening: Through-hole mounting, Adhesive
	50110192	REF 6-A-50x50	0 ... 1.2 m 0 ... 1.4 m	Design: Rectangular Reflective surface: 50 mm x 50 mm Triple reflector size: 0.3 mm Material: Plastic Chemical designation of the material: PMMA Fastening: Self-adhesive
	50003192	TK 100x100	0 ... 3 m 0 ... 3.6 m	Design: Rectangular Reflective surface: 96 mm x 96 mm Triple reflector size: 4 mm Material: Plastic Base material: Plastic Chemical designation of the material: PMMA8N Fastening: Adhesive
	50022816	TKS 100X100	0 ... 3 m 0 ... 3.6 m	Design: Rectangular Reflective surface: 96 mm x 96 mm Triple reflector size: 4 mm Material: Plastic Base material: Plastic Chemical designation of the material: PMMA8N Fastening: Through-hole mounting, Adhesive
	50081283	TKS 20X40	0 ... 1 m 0 ... 1.2 m	Design: Rectangular Reflective surface: 16 mm x 38 mm Triple reflector size: 2.3 mm Material: Plastic Base material: Plastic Chemical designation of the material: PMMA8N Fastening: Through-hole mounting, Adhesive
	50040820	TKS 40X60	0 ... 2 m 0 ... 2.4 m	Design: Rectangular Reflective surface: 37 mm x 56 mm Triple reflector size: 4 mm Material: Plastic Base material: Plastic Chemical designation of the material: PMMA8N Fastening: Through-hole mounting, Adhesive

## Dimensioned drawings

All dimensions in millimeters

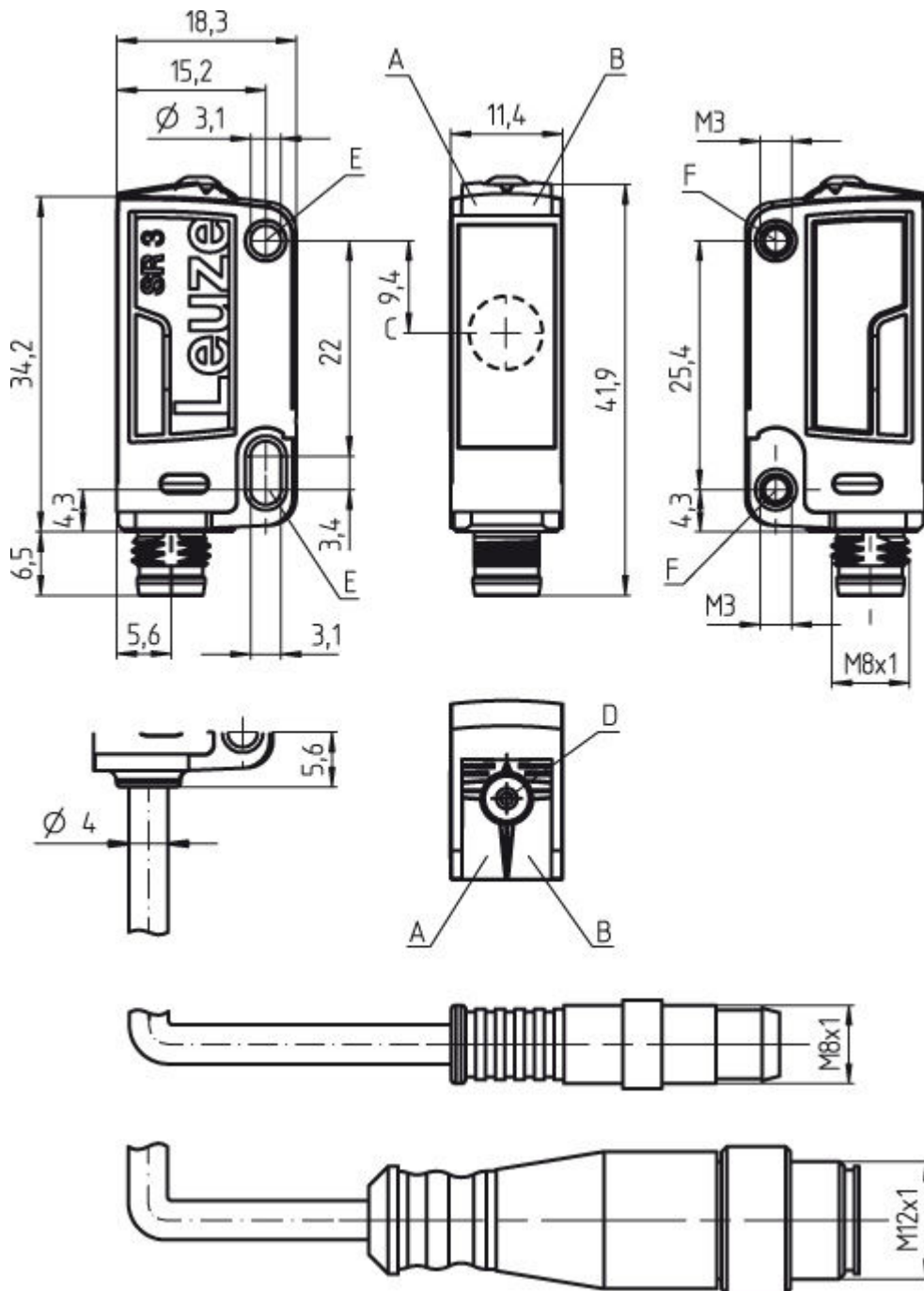

- A Green LED
- B Yellow LED
- C Optical axis
- D Teach button
- E Mounting sleeve (standard)
- F Threaded sleeve (3C.B series)

## Electrical connection

Connection 1	
Type of connection	Cable

Part no.: 50133669 – PRK3C.TT3/LP – Polarized retro-reflective photoelectric

Connection 1	
Function	Voltage supply Signal IN Signal OUT
Cable length	2,000 mm
Sheathing material	PUR
Cable color	Black
Number of conductors	4 -wire
Wire cross section	0.2 mm <sup>2</sup>

Conductor color	Conductor assignment
Brown	V+
White	OUT 2
Blue	GND
Black	IO-Link / OUT 1

## Diagrams

Typ. response behavior

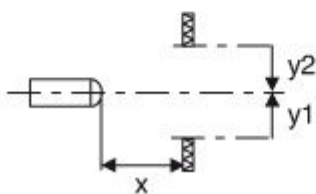
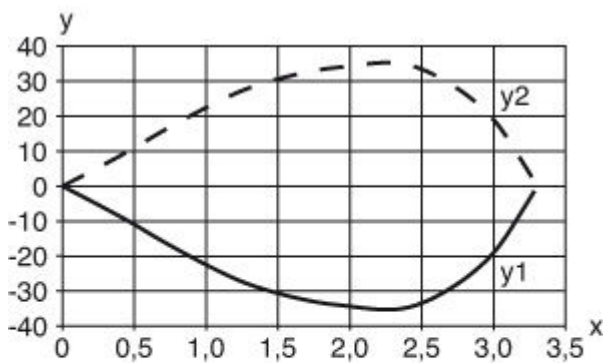

x Distance [m]  
y Misalignment [mm]

## Typ. function reserve

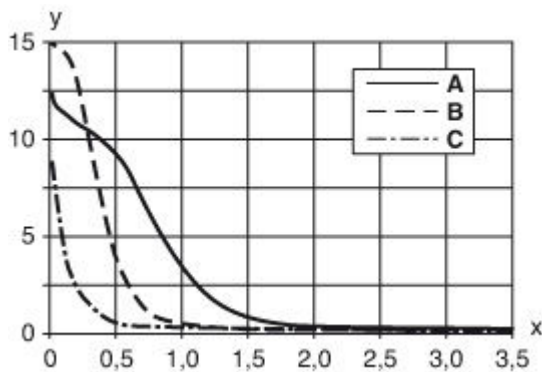

x Distance [m]  
y Function reserve  
A TKS 40x60  
B TKS 20x40  
C Film REF 4-A-50x50

## Operation and display

### LEDs

LED	Display	Meaning
1	Green, continuous light	Operational readiness
2	Yellow, continuous light	Light path free
	Yellow, flashing	Light path free, no function reserve

## Part number code

Part designation: **AAA 3C d EE-f.GG H/i J-K**





AAA3C	<b>Operating principle / construction:</b> HT3C: diffuse reflection sensor with background suppression LS3C: throughbeam photoelectric sensor transmitter LE3C: throughbeam photoelectric sensor receiver PRK3C: retro-reflective photoelectric sensor with polarization filter
d	<b>Light type:</b> n/a: red light I: infrared light
EE	<b>Light source:</b> n/a: LED L1: laser class 1 L2: laser class 2
f	<b>Pre-set range (optional):</b> n/a: operating range acc. to data sheet XXXX: pre-set range [mm]
GG	<b>Equipment:</b> n/a: standard A: autocollimation principle (single lens) for positioning tasks B: housing model with two M3 threaded sleeves, brass F: permanently set range L: long light spot S: small light spot T: autocollimation principle (single lens) for highly transparent bottles without tracking TT: autocollimation principle (single lens) for highly transparent bottles with tracking V: V-optics XL: extra long light spot

**Part no.: 50133669 – PRK3C.TT3/LP – Polarized retro-reflective photoelectric**

H	<b>Operating range adjustment:</b> n/a with HT: range adjustable via 8-turn potentiometer n/a with retro-reflective photoelectric sensors (PRK): operating range not adjustable 1: 270° potentiometer 3: teach-in via button 6: auto-teach
i	<b>Switching output/function OUT 1/IN: Pin 4 or black conductor:</b> 2: NPN transistor output, light switching N: NPN transistor output, dark switching 4: PNP transistor output, light switching P: PNP transistor output, dark switching 6: push-pull switching output, PNP light switching, NPN dark switching G: push-pull switching output, PNP dark switching, NPN light switching L: IO-Link 8: activation input (activation with high signal) X: pin not used
J	<b>Switching output / function OUT 2/IN: pin 2 or white conductor:</b> 2: NPN transistor output, light switching N: NPN transistor output, dark switching 4: PNP transistor output, light switching P: PNP transistor output, dark switching 6: push-pull switching output, PNP light switching, NPN dark switching G: push-pull switching output, PNP dark switching, NPN light switching W: warning output X: not connected (n. c.) 8: activation input (activation with high signal) 9: deactivation input (deactivation with high signal) T: teach-in via cable
K	<b>Electrical connection:</b> n/a: cable, PVC, standard length 2000 mm, 4-wire 5000: cable, PVC, standard length 5000 mm, 4-wire M8: M8 connector, 4-pin (plug) M8.3: M8 connector, 3-pin (plug) 200-M8: cable, PVC, length 200 mm with M8 connector, 4-pin, axial (plug) 200-M8.3: cable, PVC, length 200 mm with M8 connector, 3-pin, axial (plug) 200-M12: cable, PVC, length 200 mm with M12 connector, 4-pin, axial (plug)

## Accessories





### Mounting technology - Mounting brackets

	Part no.	Designation	Article	Description
	50118542	BT 200M.5	Mounting bracket	Design of mounting device: Angle, L-shape Fastening, at system: Through-hole mounting Mounting bracket, at device: Screw type Type of mounting device: Adjustable Material: Stainless steel
	50124651	BT 205M-10SET	Mounting device set	Contains: 10x Design of mounting device: Angle, L-shape Fastening, at system: Through-hole mounting Mounting bracket, at device: Screw type Type of mounting device: Rigid Material: Metal
	50060511	BT 3	Mounting device	Design of mounting device: Angle, L-shape Fastening, at system: Through-hole mounting Mounting bracket, at device: Screw type Type of mounting device: Rigid Material: Metal
	50105585	BT 3.1	Mounting strap set	Contains: 10x Design of mounting device: Retaining clip Fastening, at system: Through-hole mounting Mounting bracket, at device: Screw type Type of mounting device: Rigid Material: Metal



**Part no.: 50133669 – PRK3C.TT3/LP – Polarized retro-reflective photoelectric**

	Part no.	Designation	Article	Description
	50105546	BT 3B	Mounting device	Design of mounting device: Angle, L-shape Fastening, at system: Through-hole mounting Mounting bracket, at device: Screw type Type of mounting device: Rigid Material: Metal



**Mounting technology - Rod mounts**

	Part no.	Designation	Article	Description
	50117256	BTU 200M-D10	Mounting system	Contains: 2x M3 x 18 screw, 2x position washers Design of mounting device: Mounting system Fastening, at system: For 10 mm rod, Sheet-metal mounting Mounting bracket, at device: Screw type Type of mounting device: Clampable, Adjustable, Turning, 360° Material: Metal
	50117255	BTU 200M-D12	Mounting system	Contains: 2x M3 x 18 screw, 2x position washers Design of mounting device: Mounting system Fastening, at system: For 12 mm rod, Sheet-metal mounting Mounting bracket, at device: Screw type Type of mounting device: Clampable, Adjustable, Turning, 360° Material: Metal
	50117254	BTU 200M-D14	Mounting system	Contains: 2x M3 x 18 screw, 2x position washers Design of mounting device: Mounting system Fastening, at system: For 14 mm rod, Sheet-metal mounting Mounting bracket, at device: Screw type Type of mounting device: Clampable, Adjustable, Turning, 360° Material: Metal
	50120426	BTU 200M.5-D12	Mounting system	Contains: 2x M3 x 18 screw, 2x M3 mounting nut, 2x position washers Design of mounting device: Mounting system Fastening, at system: For 12 mm rod Mounting bracket, at device: Screw type Type of mounting device: Turning, 360°, Clampable, Adjustable Material: Stainless steel

**Standard reflectors**

	Part no.	Designation	Article	Description
	50134985	MTKS 20x30.1	Reflector	Design: Rectangular Reflective surface: 18.5 mm x 28.5 mm Triple reflector size: 1 mm Material: Plastic Base material: Plastic Chemical designation of the material: PMMA Fastening: Through-hole mounting, Adhesive
	50003192	TK 100x100	Reflector	Design: Rectangular Reflective surface: 96 mm x 96 mm Triple reflector size: 4 mm Material: Plastic Base material: Plastic Chemical designation of the material: PMMA8N Fastening: Adhesive
	50022816	TKS 100X100	Reflector	Design: Rectangular Reflective surface: 96 mm x 96 mm Triple reflector size: 4 mm Material: Plastic Base material: Plastic Chemical designation of the material: PMMA8N Fastening: Through-hole mounting, Adhesive

**Part no.: 50133669 – PRK3C.TT3/LP – Polarized retro-reflective photoelectric**



	Part no.	Designation	Article	Description
	50081283	TKS 20X40	Reflector	Design: Rectangular Reflective surface: 16 mm x 38 mm Triple reflector size: 2.3 mm Material: Plastic Base material: Plastic Chemical designation of the material: PMMA8N Fastening: Through-hole mounting, Adhesive
	50040820	TKS 40X60	Reflector	Design: Rectangular Reflective surface: 37 mm x 56 mm Triple reflector size: 4 mm Material: Plastic Base material: Plastic Chemical designation of the material: PMMA8N Fastening: Through-hole mounting, Adhesive

**Micro-triad-type reflectors**



	Part no.	Designation	Article	Description
	50117583	MTKS 50x50.1	Reflector	Design: Rectangular Reflective surface: 50 mm x 50 mm Triple reflector size: 1.2 mm Material: Plastic Base material: Plastic Chemical designation of the material: PMMA8N Fastening: Through-hole mounting, Adhesive

**Reflective tapes for laser and clear-glass applications**

	Part no.	Designation	Article	Description
	50110192	REF 6-A-50x50	Reflective tape	Design: Rectangular Reflective surface: 50 mm x 50 mm Triple reflector size: 0.3 mm Material: Plastic Chemical designation of the material: PMMA Fastening: Self-adhesive

	Part no.	Designation	Article	Description
	50131483	MD 248i-12-8K/ L4-2R2K	Distribution box	Type: IO-Link master Supply voltage: 18 ... 30 V Switching outputs for each sensor connection: 1 Piece(s) Switching output: Transistor, PNP / NPN reversible Interface: PROFINET, IO-Link Connections: 14 Piece(s) Sensor connections: 8 Piece(s) Connections for voltage supply: 4 Piece(s) Interface connections: 2 Piece(s) Degree of protection: IP 67
	50131485	MD 258i-12-8K/ L4-2R2K	Distribution box	Type: IO-Link master Supply voltage: 18 ... 30 V Switching outputs for each sensor connection: 1 Piece(s) Switching output: Transistor, PNP / NPN reversible Interface: EtherNet IP, IO-Link, Modbus TCP Connections: 14 Piece(s) Sensor connections: 8 Piece(s) Connections for voltage supply: 4 Piece(s) Interface connections: 2 Piece(s) Degree of protection: IP 67

**Part no.: 50133669 – PRK3C.TT3/LP – Polarized retro-reflective photoelectric**

	Part no.	Designation	Article	Description
	50131482	MD 748i-11-42/ L5-2222	Distribution box	Type: IO-Link master Supply voltage: 18 ... 30 V Switching outputs for each sensor connection: 1 Piece(s) Switching output: Transistor, PNP / NPN reversible Interface: PROFINET, IO-Link Connections: 8 Piece(s) Sensor connections: 4 Piece(s) Connections for voltage supply: 2 Piece(s) Interface connections: 2 Piece(s) Degree of protection: IP 67
	50131484	MD 758i-11-42/ L5-2222	Distribution box	Type: IO-Link master Supply voltage: 18 ... 30 V Switching outputs for each sensor connection: 1 Piece(s) Switching output: Transistor, PNP / NPN reversible Interface: EtherNet IP, IO-Link, Modbus TCP Connections: 8 Piece(s) Sensor connections: 4 Piece(s) Connections for voltage supply: 2 Piece(s) Interface connections: 2 Piece(s) Degree of protection: IP 67

## Notes

### Observe intended use!

- This product is not a safety sensor and is not intended as personnel protection.
- The product may only be put into operation by competent persons.
- Only use the product in accordance with its intended use.

### For UL applications:

- For UL applications, use is only permitted in Class 2 circuits in accordance with the NEC (National Electric Code).
- These proximity switches shall be used with UL Listed Cable assemblies rated 30V, 0.5A min, in the field installation, or equivalent (categories: CYJV/CYJV7 or PVVA/PVVA7)

- Light source: Average life expectancy 100,000 h at an ambient temperature of 25 °C
- Response time: For short decay times, an ohmic load of approx. 5 kOhm is recommended
- Sum of the output currents for both outputs, 50 mA for ambient temperatures > 40 °C
- Permissible operating temperature range during IO-Link operation: -10 °C to +40 °C
- Use of MTK(S) or REF 6-A- reflective tape is preferred.
- For REF 6-A reflective tape, the sensor's side edge must be aligned parallel to the side edge of the reflective tape.
- The light spot may not exceed the reflector.